



Cover 1:
Sublime Marble

Cover 2:
Beehive Pastel

Cover 3:
Polka Pebble

Chrome feet

Flair Collection

Colours represented are to be used as a guide only.
Please refer to manufacturers swatch for a more accurate colour match.

Please note that colour shadings can vary slightly from each roll of fabric.
We cannot guarantee a precise match to these samples or between cut lengths and upholstered goods.

Extra Flex[®]
Soft, Supportive Seating

10/06/2021

FLAIR COVER GUIDE: STANDARD BACK

Please use this guide when ordering the following pieces to clarify cover options.

STANDARD BACK - Available with or without studs

LH2, COR, RH2 Corner Group

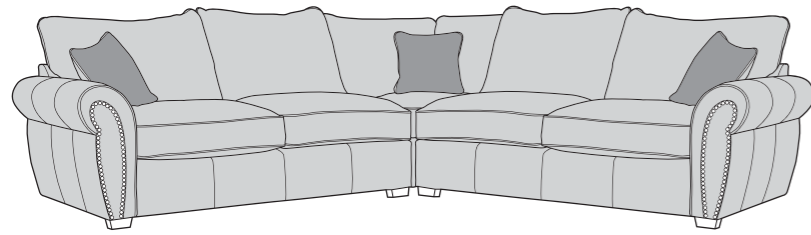

LH2, RFC, FST Corner Group

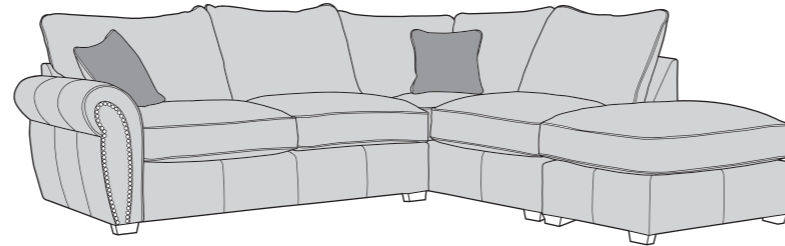

FST, LFC, RH2 Corner Group

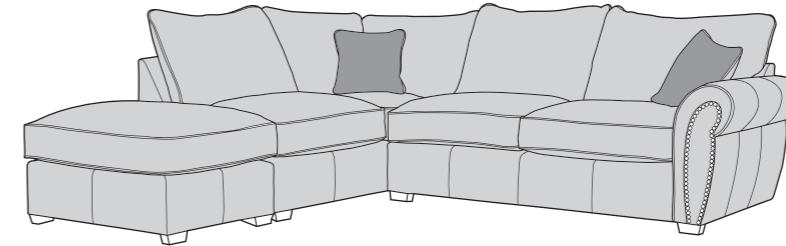

LH2, COR, RH1 Corner Group

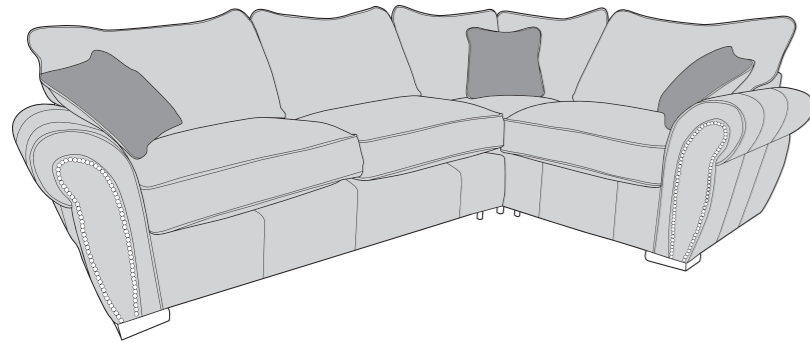

LH1, COR, RH2 Corner Group

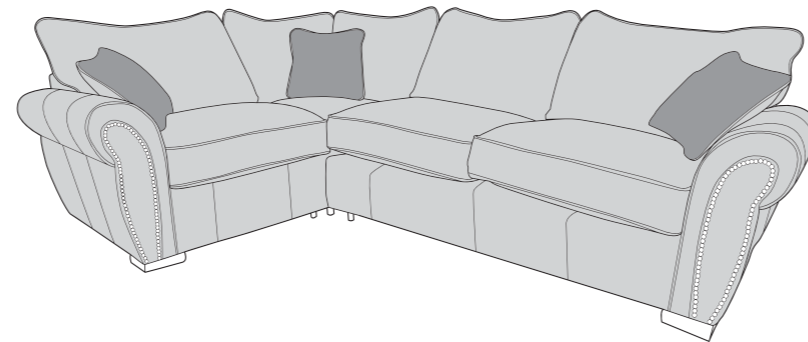

LH1, COR, RH1 Corner Group

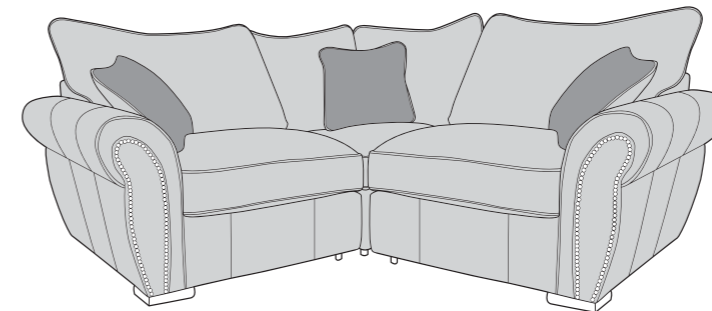

Armless Unit (ALU)

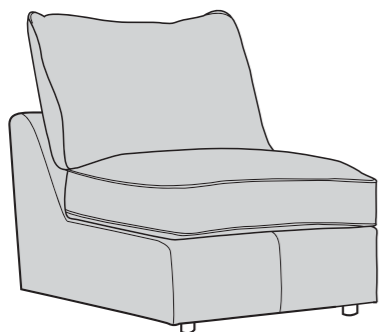

3 Seater Sofa (3ST)

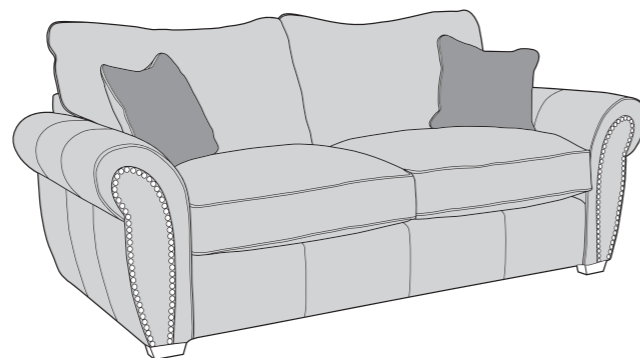

2 Seater Sofa (2ST)

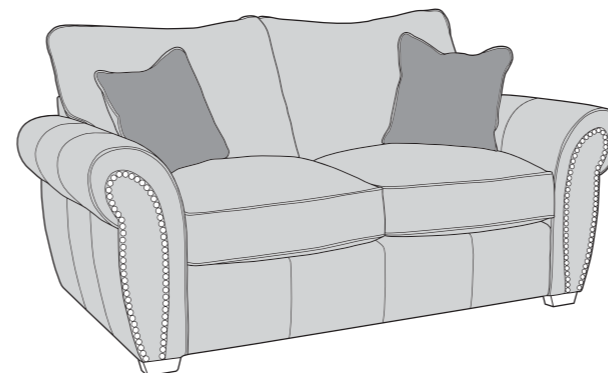

Arm Chair (1ST)

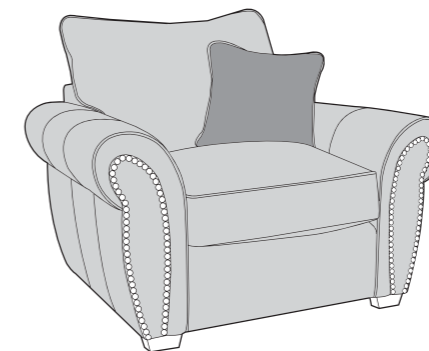

-  **COVER 1**
(BODY)
-  **COVER 2**
(SCATTER)

Standard Back Scatter Cushions

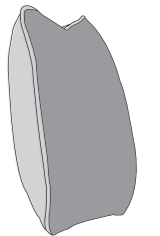

Front = Cover 2
Piping = Cover 1
Back = Cover 1



APPROVED MEMBER



FLAIR COVER GUIDE: PILLOW BACK

Please use this guide when ordering the following pieces to clarify cover options.

PILLOW BACK - Available with or without studs

LH2, COR, RH2 Corner Group

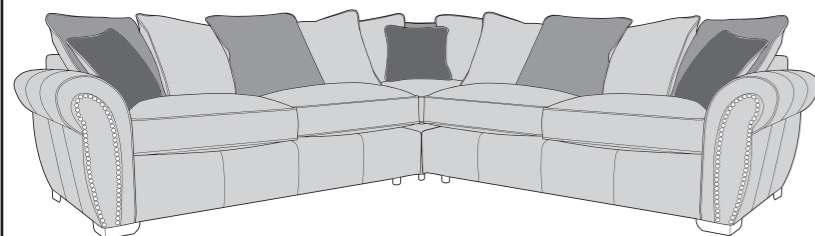

LH2, RFC, FST Corner Group

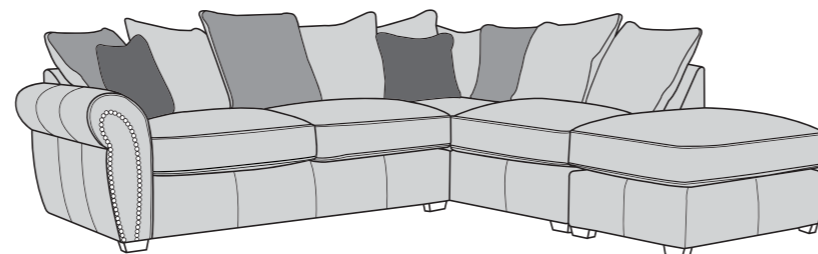

FST, LFC, RH2 Corner Group

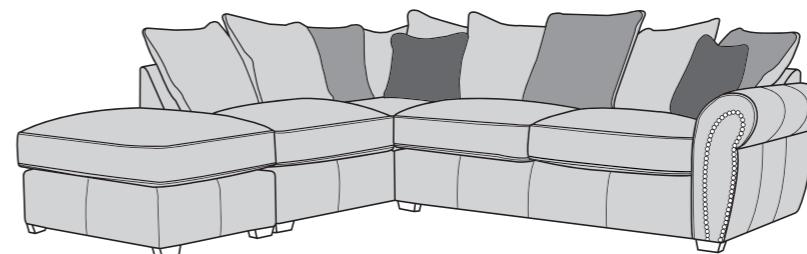

LH2, COR, RH1 Corner Group

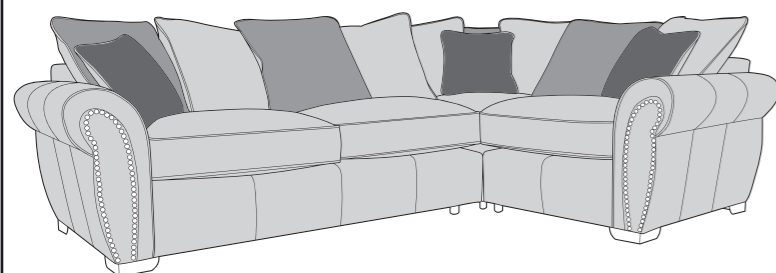

LH1, COR, RH2 Corner Group

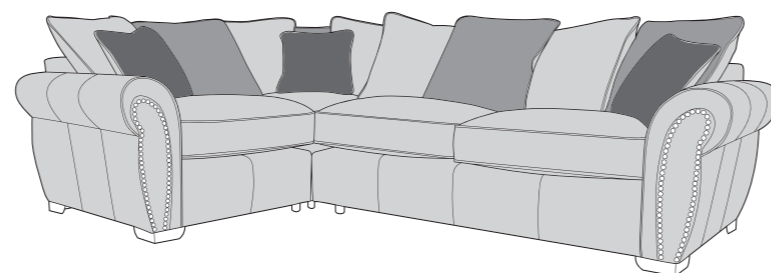

LH1, COR, RH1 Corner Group

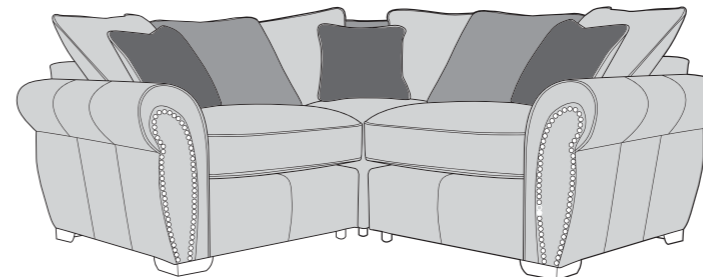

Armless Unit (ALU)

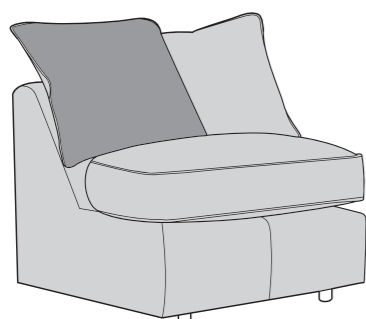

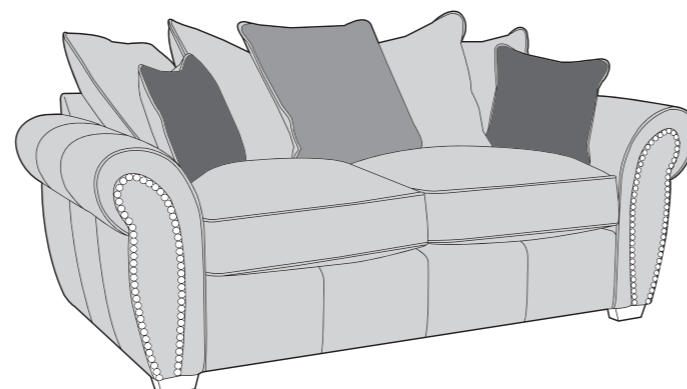

3 Seater Sofa (3ST)

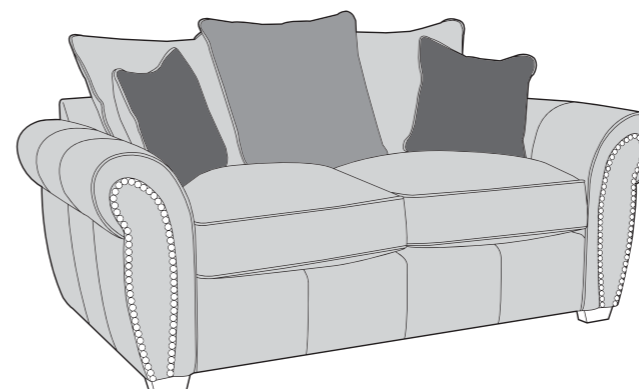

2 Seater Sofa (2ST)



-  **COVER 1**
(BODY)
-  **COVER 2**
(PILLOW)
-  **COVER 3**
(SCATTER)

Pillow Back Cushions

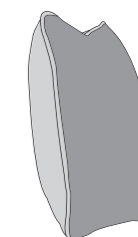

Front = Cover 2
Piping = Cover 1
Back = Cover 1

Pillow Back Scatter Cushions

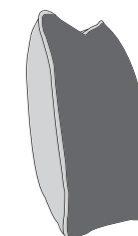

Front = Cover 3
Piping = Cover 1
Back = Cover 1

SUGGESTED ACCENT PIECES

Round Footstool (FST)

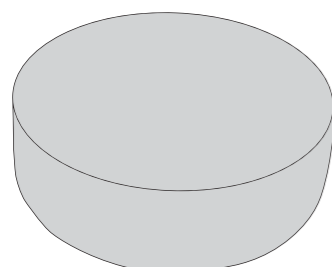

Large Footstool P (FST)

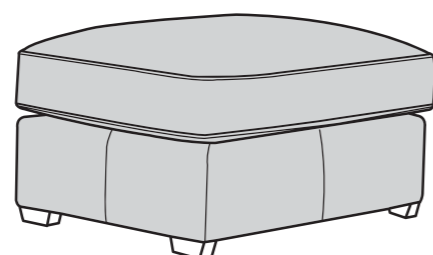

FLAIR DIMENSIONS (CM)

AVAILABLE PIECES	HEIGHT 1	WIDTH 2	DEPTH 3	SEAT HEIGHT 4	SEAT DEPTH (STD) 5	SEAT DEPTH (PILLOW) 5	SEAT WIDTH 6	ACCESS DIAGONAL 7	WEIGHT (KG)	PILLOW BACK NO.	SCATTER CUSHION NO.
LH2, COR, RH2 GROUP	95	288	288	55	N/A	N/A	N/A	N/A	129	11 (5 PATTERN, 6 PLAIN)	3
LH2, COR, RH1 GROUP or LH1, COR, RH2 GROUP	95	288	202	55	N/A	N/A	N/A	N/A	111.5	9 (4 PATTERN, 5 PLAIN)	3
LH1, COR, RH1 GROUP	95	202	202	55	N/A	N/A	N/A	N/A	94	7 (3 PATTERN, 4 PLAIN)	3
LH2, RFC, FST GROUP or RH2, LFC, FST GROUP	95	288	246	55	N/A	N/A	N/A	N/A	118.5	9 (3 PATTERN, 6 PLAIN)	2
LH2/RH2 UNIT	95	193	95	55	63	63	163	212	50.5	4 (2 PATTERN, 2 PLAIN)	1
LH1/RH1 UNIT	95	107	95	55	63	63	79	143	33	2 (1 PATTERN, 1 PLAIN)	1
LFC/RFC UNIT	95	177	95	55	63	63	146	198	50	5 (1 PATTERN, 4 PLAIN)	1
COR - CORNER UNIT	95	95	95	55	N/A	N/A	N/A	135	28	3 (1 PATTERN, 2 PLAIN)	1
ALU - ARMLESS UNIT	95	79	95	55	63	63	79	124	30	2 (1 PATTERN, 1 PLAIN)	N/A
LARGE FOOTSTOOL (FST)	55	69	95	N/A	N/A	N/A	N/A	116	18	N/A	N/A
3 SEATER SOFA (3ST)	95	218	95	55	63	63	160	229	61.5	5 (1 PATTERN, 4 PLAIN)	2
2 SEATER SOFA (2ST)	95	190	95	55	63	63	132	204	53	3 (1 PATTERN, 2 PLAIN)	2
ARM CHAIR (1ST)	95	118	95	55	63	63	59	143	39	N/A	1
ACCENT PIECES											
ROUND FOOTSTOOL	33	97	97	N/A	N/A	N/A	N/A	N/A	22	N/A	N/A
STORAGE FOOTSTOOL	45	63	50	N/A	N/A	N/A	N/A	N/A	12.5	N/A	N/A



- * Hardwood & composite board frame.
- * Dowelled, screwed, glued & stapled joinery.
- * Chrome & Wood foot options.

- * Available with Pillow or Standard back cushions.
- * Extraflex high comfort seat cushions.
- * Fibre filled backs for added comfort.

- * Serpentine seat springs & silent wire.
- * Superloop back springs

DIMENSION GUIDE

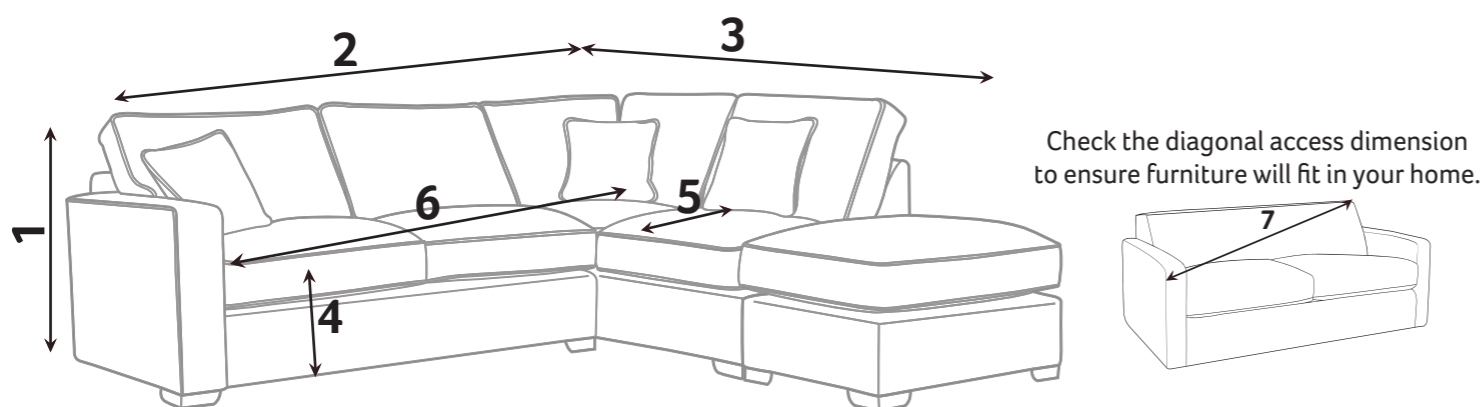

- 1 - HEIGHT
- 2 - WIDTH
- 3 - DEPTH
- 4 - SEAT HEIGHT
- 5 - SEAT DEPTH (STD & PILLOW)
- 6 - SEAT WIDTH
- 7 - DIAGONAL ACCESS

Illustrations used for reference only.

Extra Flex®

A high density foam base seat interior with a hand-rolled carded fibre, channelled topper which provides both softness and support.

CARE GUIDE

Extraflex seat cushions should be **plumped up on a regular basis** to help maintain the aesthetical appeal of your upholstery, the plumping of cushions is essential to help retain the comfort and softness of any piece of upholstered furniture.

To improve the longevity of your hand-made furniture, we recommend rotating cushions (where applicable).

For further information on maintaining your furniture please refer to the care guide located under the seat platform.

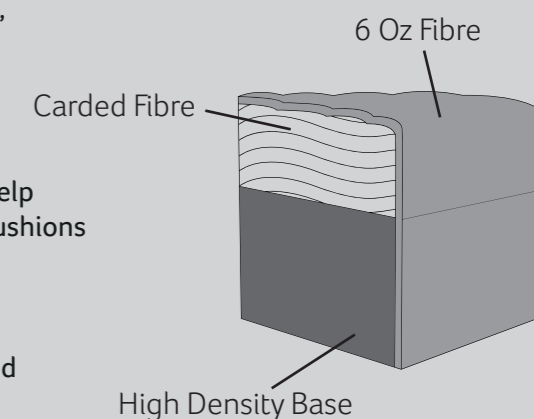

Beech (light) Antique (dark) Chrome

FOOT OPTIONS:



Wood is a natural product and will vary in shade/colour from item to item. Feet may require fitting.

Please note : All dimensions are approximate. Allow tolerance of +/- 2.5cm.



10/06/2021